

#2 Line Follower



1

4X 0.5" Bolt + Nut

1X Med. Plate

2X C Small Bar

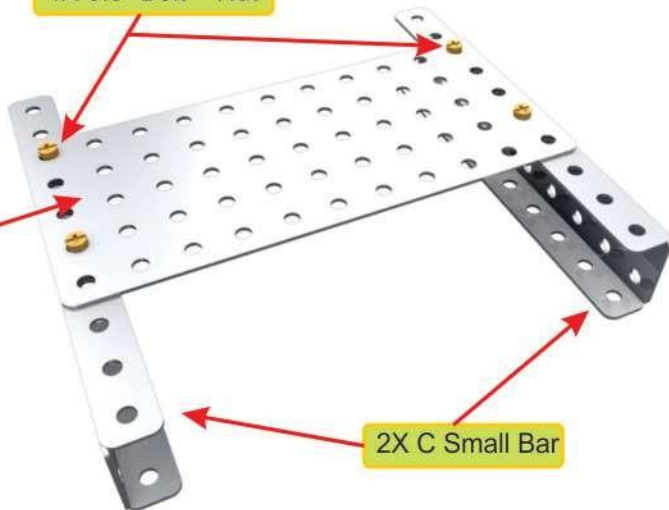

2

2X Motor

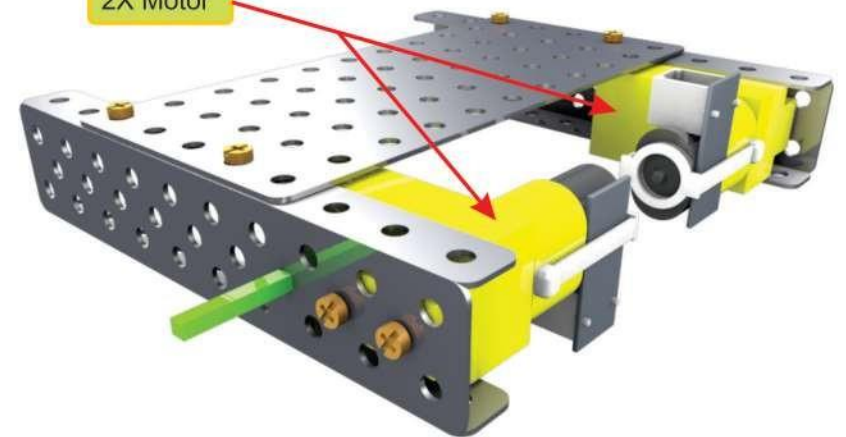

3

2X Wheel

2X Axle Lock

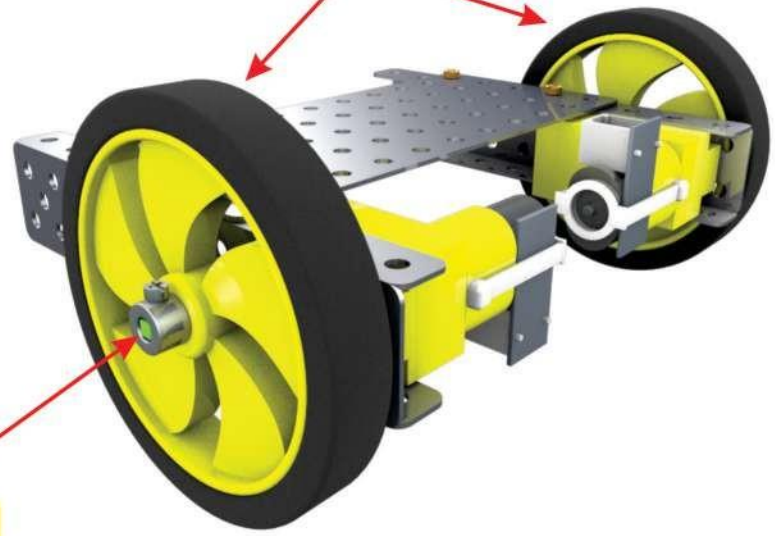

4

4X 0.5" Bolt + Nut

2X L Small Bar

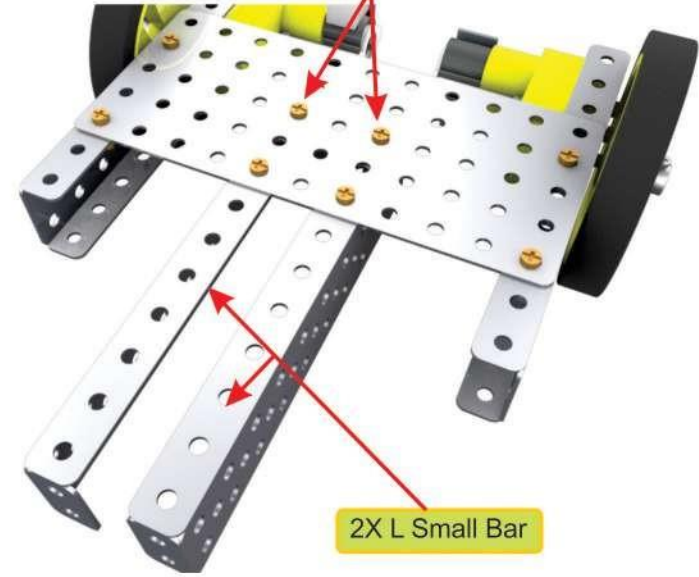

5

2X 0.5" Bolt + Nut

1X Caster + Caster Strip

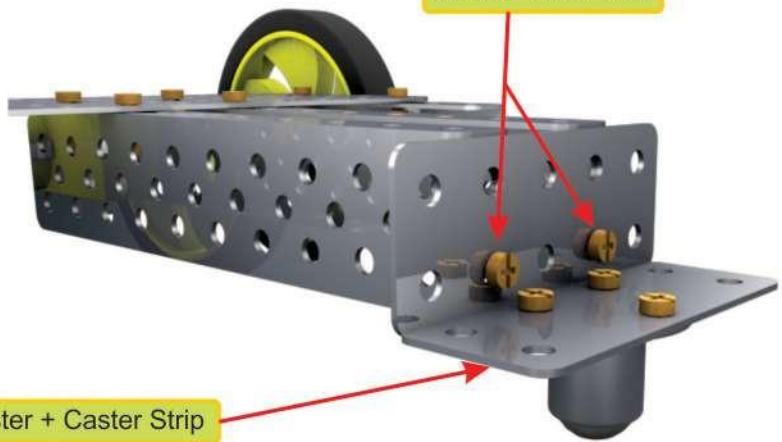

6

IR Sensors

4X 0.5" Bolt + Nut

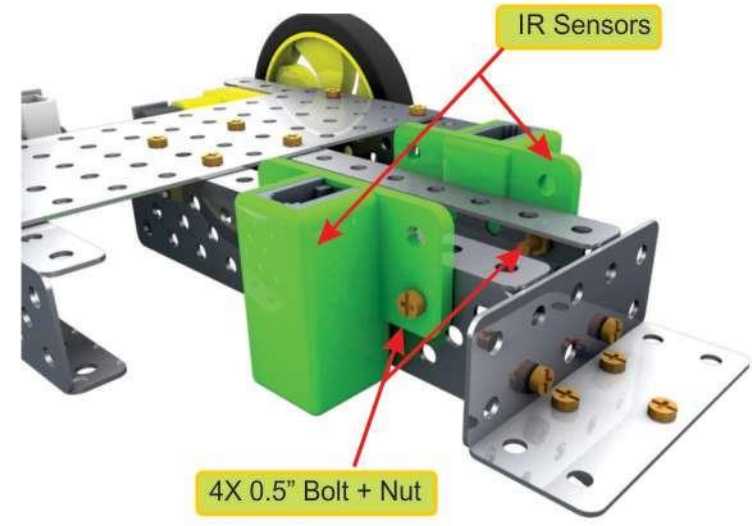

7

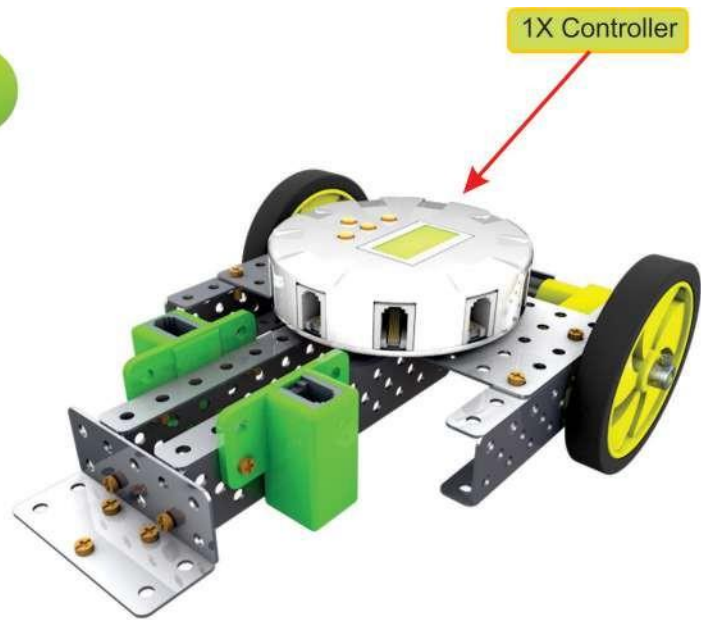

What did you learn?



Tutorial Link

<https://www.youtube.com/embed/J5e8ssLKJXU?si=zk4XbozHvhlZzOg3>